

# ESPRESSO OFFICE

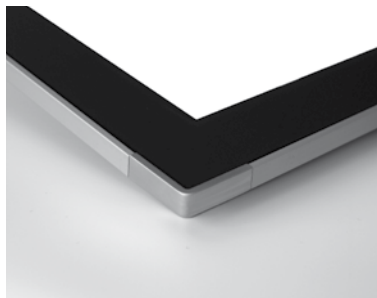

LA COMUNICAZIONE VISIVA NELL' ARREDAMENTO  
VISUELLE KOMMUNIKATION FÜR RAUM & GESTALTUNG  
VISUAL COMMUNICATIONS FOR FURNISHINGS & OPEN SPACES



<b>SIGNAGE</b> SIGNCODE®	4
<b>PRESENTATION</b> PIXQUICK®   MAGINFO SLIM	6 7
<b>INFO POINT</b> IPOINT MEDIA   IPOINT	8 9
<b>CROWD CONTROL</b> STOPPER POINT   TEX ALU	10 11
<b>BANNER FRAME   ACOUSTIC PANEL</b> FRAMFRAME   SILENTIS	12 14
<b>PARTITION</b> DIGIPRESSTO	16
<b>MODULAR CUBES</b> CONNECTOR	17
<b>PARTITION</b> ixBOND	18
<b>INTERIOR</b> SOISTES® POLE   STORE   FLY	20 21 22
<b>PRESENTATION</b> SNAPIN	23
<b>BROCHURE DISPLAY</b> DACAPO   DACAPO IPOINT REAL ZIP	24 25 26
<b>ILLUMINATION</b> LUMO	28
<b>FIXINGS</b> FISSO four	29
<b>TECHNICAL DETAILS</b>	30-36

# WELCOME

**IT** | l'ufficio è un luogo che influenza sia chi vi lavora che i visitatori e i clienti. È quindi importante che la prima impressione sia armoniosa e professionale fin nei minimi dettagli. scoprite insieme a noi il mondo della comunicazione visiva e in che modo vi renderà possibile innovare il vostro ufficio.

**DE** | geschäftsräume wirken auf doppelte weise: nach innen auf die mitarbeiter und nach aussen auf ihre besucher und kunden. es ist wichtig, dass diese wirkung auch im detail stimmig und professionell ist. entdecken sie mit uns auf den folgenden seiten in die welt der visuellen kommunikation und überzeugen sie sich selbst, was im office-bereich alles möglich ist.

**EN** | business rooms affect internally the staff and externally the customers and visitors. it is important that this impression is harmonious and professional also in its detail. join us now on the following pages in the world of visual communications and discover what it can bring to your office.

innovation in visual communication  
 innovation in visual communication  
 innovation in visual communication  
 innovation in visual communication

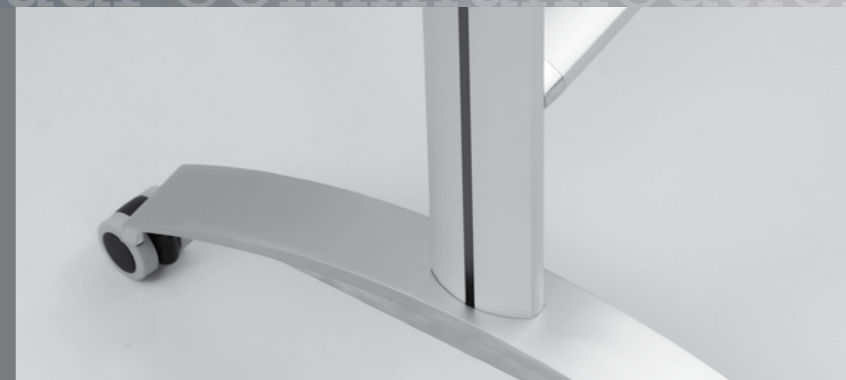
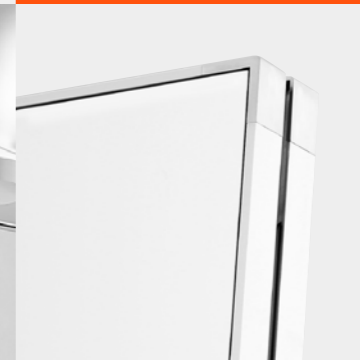

# SIGNAGE



**SIGNCODE®** patented

clever design, stylish look, smart use.

**IT |** signcode® vi consente di creare all'interno di un edificio un sistema di orientamento veloce e di design: questo innovativo sistema di segnaletica è adattabile e applicabile a parete, a bandiera e a sospensione. due versioni sono a vostra disposizione: con stampa digitale su pannelli in alluminio per informazioni di permanenti o con stampa su carta protetta con pannello trasparente. entrambe le versioni sono a prova di manomissione grazie alla loro chiusura di sicurezza, ciò nonostante le informazioni sono facilmente intercambiabili senza smontare l'intero sistema e senza l'utilizzo di particolari attrezzi.

**DE |** die schnelle orientierung in einem gebäude mit durchgängigem design bietet ihnen signcode®, das clevere leitsystem: ob an der wand, als auslegerschild oder deckenabgehängt, diese beschilderung eignet sich für alle anforderungen. es gibt zwei versionen: für langfristige info der direktdruck auf alu-paneel und für die schnellwechsel-variante papierdruck hinter transparenter abdeckung. alle versionen sind mit sicherheitsverschluss gegen unerwünschte manipulation ausgestattet und können jederzeit ohne demontage oder spezial-werkzeug gewechselt werden.

**EN |** quick orientation in a building with one corporate design is what signcode® offers you: this clever signage is available for walls, as flag signs or for ceiling suspension. it is suitable for all these applications. signcode® comes in two versions: digital printing on aluminium panels for long-term information and paper-print under a transparent cover. both versions have a security lock and are thus tamper-proof. nonetheless the information can be exchanged easily anytime without demounting or special tools.



print not included

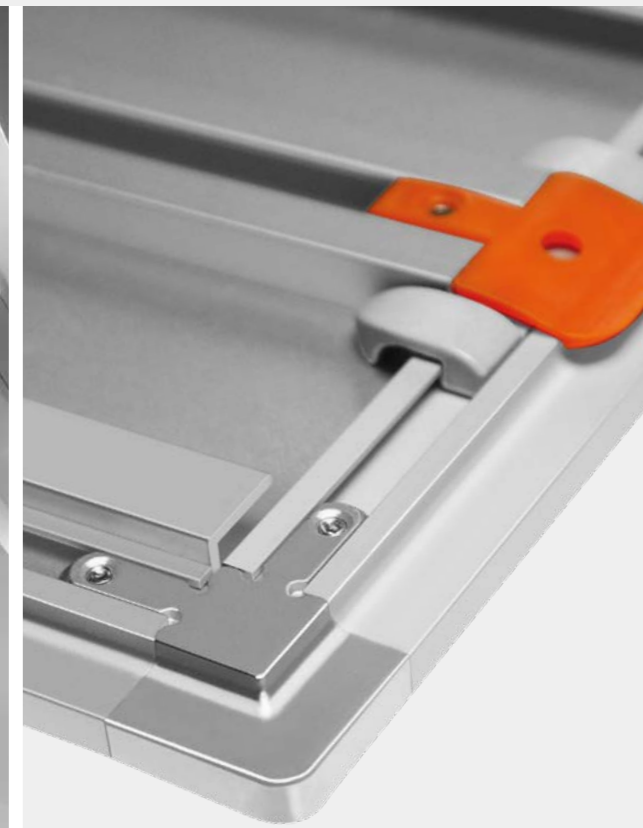

FSOS105600AL	signcode suspension 105x600mm with alu panel, 1pc
FSOW210210PS	signcode wall 210x210mm with PS panel, 1pc
FSOF148148AL	signcode flag 148x148mm with alu panel, 1pc

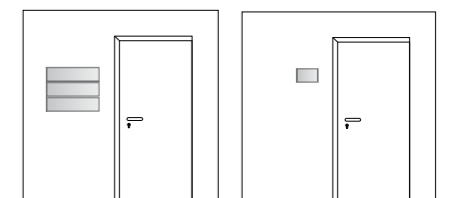
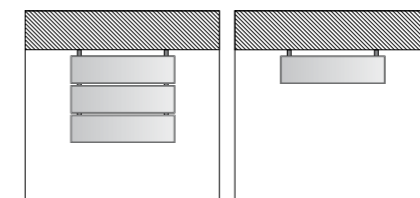
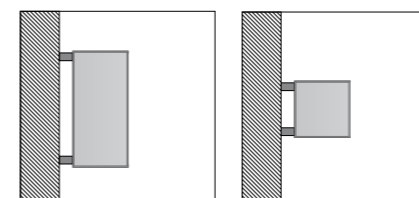
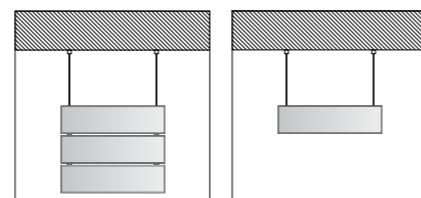

# PRESENTATION



## PIXQUICK® patented

frameless, easy mounting, quick exchange

**IT |** si chiama pixquick® la cornice in formato A3 senza bordi, leggermente curva e in policarbonato di alta qualità stampata a iniezione, un display ben fatto e discreto adatto ad ogni ambiente. il montaggio avviene semplicemente tramite nastro biadesivo o viti ed è perfetta per informazioni, decorazioni, promozioni o segnaletica direzionale interna. per cambiare l'informazione basta aprire la parte frontale

**DE |** pixquick® heisst dieses rahmenloses leicht gebogene display aus hochwertigem polycarbonat-spritzguss für einzelblatt-info in A3. schnell montiert mit doppelkleber oder schrauben ist es perfekt für information, dekoration, werbung oder beschilderung. für den info-austausch klappen sie einfach die front auf. ein dezentes, formschönes display für jedes ambiente.

**EN |** pixquick® is the name of this frameless, slightly curved, display made of high-grade die-cast polycarbonate. the A3 format frame is quickly mounted with double-adhesive tape or wall screws and it is perfect for information, decoration, promotion or signage. to exchange the information simply open the cover. a decent yet shapely display for every ambience.

PQA3 pixquick A3, without support, 1pc



banner not included

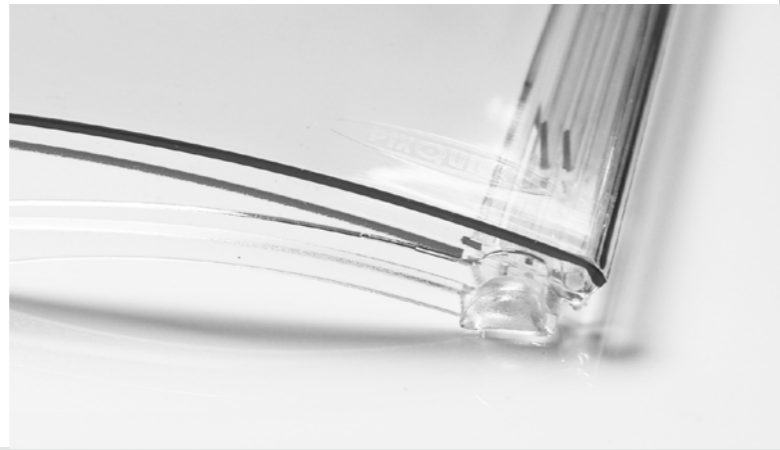

# PRESENTATION

## MAGINFO SLIM

freestanding, double benefit

**IT |** un display da terra autoportante con due funzioni: presentazione di poster e portacataloghi. il poster può essere cambiato velocemente grazie alle strisce magnetiche che mantengono in posizione il foglio protettivo anti-riflesso. i due ripiani in materiale acrilico sono l'ideale per brochure in formato A4 e flyers. tutti i materiali sono di alta qualità e di lunga durata. il vostro maginfo slim farà della vostra presentazione un successo a lungo termine!

**DE |** ein freistehendes bodendisplay mit doppel-funktion: poster-präsentation und katalog-dispenser. die poster-info kann jederzeit schnell gewechselt werden und die magnetstreifen halten die reflektionsarme abdeckung sicher fest. die beiden ablagen aus satiniertem acrylglas bieten platz für kataloge oder flyer in A4. alle materialien sind hochwertig und langlebig, so dass sie an ihrem maginfo slim lange freude haben.

**EN |** freestanding floor display with a double use: poster presentation and catalogue dispenser. the poster can be exchanged quickly at anytime as the magnetic tapes keep the non-reflective transparent cover safely in place. the two trays made of satin acrylic are best for A4 brochures and flyers. all materials are high-grade and long living. your maginfo slim will make your presentation a long-term success.

SOMS700500 maginfo slim 700x500mm, 1pc

SOTR2A4TR tray 2 A4 V, 1pc



banner not included



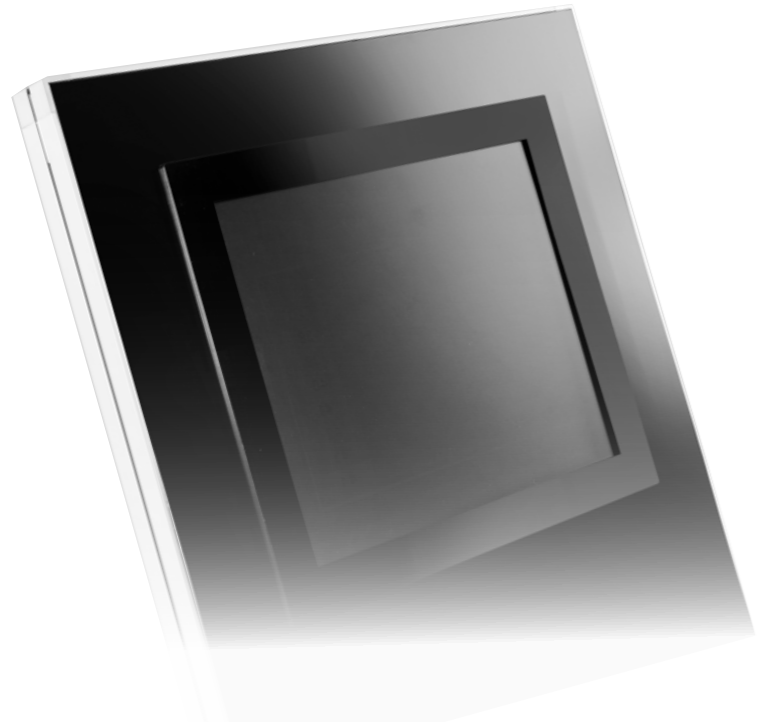

## IPOINT MEDIA | IPOINT

multimedia and flexible

**IT |** il nostro display per informazioni autoportante chiamato ipoint vi aprirà la strada. può essere personalizzato con stampa digitale diretta o tramite applicazione di pellicole. in aggiunta l'ipoint media mette a vostra disposizione un display LCD di alta qualità per la presentazione di immagini o video attraverso SD card o USB stick. sono disponibili ulteriori accessori quali ripiani e barre che renderanno il vostro ipoint unico nel suo genere.

**DE |** unsere freistehenden info pylonen aus der ipoint serie zeigen wo's lang geht. die ipoint lassen sich mit digitaldruck oder aufkaschierten motiven personalisieren. die ipoint media bieten zusätzlich ein hochwertiges lcd display für die präsentation von bildern oder video-clips über usb-stick oder sd-karte. zusätzliche accessoires wie ablagen oder ausleger machen aus den info-stelen ein individuell zugeschnittenes informations-display.

**EN |** our freestanding information displays called ipoint will show you the right way. they can be customized with direct digital printing or laminated images. additionally the ipoint media offers a high-grade lcd display for the presentation of images or videos with usb-stick or sd-cards. additional accessories such as trays or bars turn your ipoint into an individual set up information display.

IPM17 ipoint media 17", black, 1pc

IP1900600ARW ipoint 1900x600, silver/white, 1pc



print not included

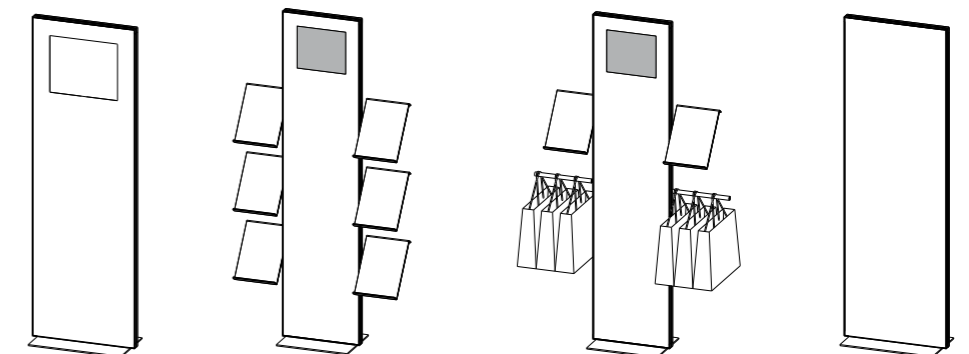

examples



## STOPPER POINT

stand in line with italian design

**IT |** gestire code ed indirizzare il flusso delle persone sono il presupposto di un sistema guidalinee. stopper point assolve perfettamente questo compito: la stabilità, i materiali di prim'ordine, l'alluminio a prova di impronte, il nastro anti-grinza e il suo riavvolgimento controllato del nastro rendono questo sistema sicuro e affidabile.

**DE |** menschen leiten und bereiche sichern sind die aufgaben eines personenleitsystems. stopper point erfüllt diese aufgabe in jeder hinsicht: hohe standfestigkeit, hochwertige materialien, fingerabdruck - resistentes aluminium, knitterfreier gurt und abgeregelter gurteinzug machen dieses system sicher und zuverlässig in jeder hinsicht.

**EN |** manage the queue and control the crowd is the purpose of a guide line system. stopper point is doing this perfectly: firm stand, first-grade materials, finger-proof resistant aluminium, crease resistant webbing and a controlled recoil makes this system safe and reliable in every respect.

SCPALARGSW stopper point alu with black ribbon, 1pc



## STOPPER TEX ALU

classic guide line with cord

**IT |** un sistema guidalinee classico con un design fresco e moderno, stiamo parlando del nostro tex alu. materiali di prim'ordine, corde colorate resistenti alla polvere e alla sporcizia ed una base stabile in ABS sintetico rendono questo classico un prodotto che attira l'attenzione.

**DE |** ein klassisches leit- und abperrsystem mit frischem design und modernen materialien ist unser tex alu. hochwertige materialien, ein schmutzabweisendes farbechtes seil und eine stabile basis mit trittschutzring aus kunststoff machen aus diesem klassiker einen trendigen hingucker.

**EN |** a classic guide line system with a fresh design and modern materials, that is our tex alu. first class materials, a soil-resistant color-fast cord and a stable base with step-on protection made of ABS synthetics turn this classic product into a trendy eye catcher.

TXAL set stopper tex alu, 1pc  
 TEXSCMGR150 rope grey 1,5m with chrome-plated supports, 1pc



# BANNER FRAME

## FRAMFRAME

for wall, floor and ceiling

**IT |** semplicemente geniale: la cornice per tessuti framframe è un elemento decorativo da parete, un sistema a sospensione da soffitto o una parete divisoria. lo speciale design della cornice mette in risalto il banner. a fianco al banner potrete notare solo un piccolo bordo di 2 mm. framframe può essere monofacciale o bifacciale. il banner in tessuto può essere cambiato facilmente ed in ogni momento senza bisogno di utensili. in questo modo il vostro ufficio sarà sempre all'avanguardia e di tendenza.

**DE |** einfach genial: framframe rahmensystem für textile banner lässt sich perfekt als dekoratives wandobjekt, als deckenabhängung oder toller raumtrenner einsetzen. das spezielle design gibt dem banner den vortritt, vom rahmen sehen sie vorne nur dezente 2mm. framframe systeme können ein- oder zweiseitig bespannt werden. die stoffbanner mit kedersystem lassen sich jederzeit ohne werkzeug einfach austauschen. so ist der passende look für ihr office immer modisch aktuell und im trend.

**EN |** simply brilliant: the framframe system for textile banners is a decorative wall element, a cozy ceiling suspension or a trendy partition. the special design of the frame puts the banner in the front line. next to the banner right in front you can see only a tiny border of 2mm. framframe can be used single or double sided. the textile banners can be easily exchanged anytime without any tools. thus the matching look for your office is always in vogue and trendy.

FFR19001260	1900x1260mm, 1pc
FFR1500500	1500x500mm, 1pc

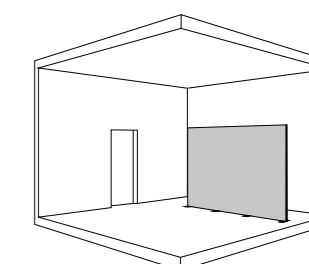
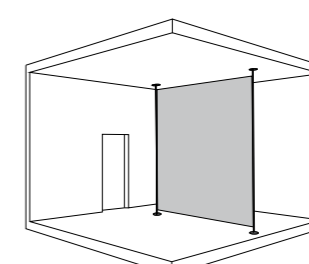
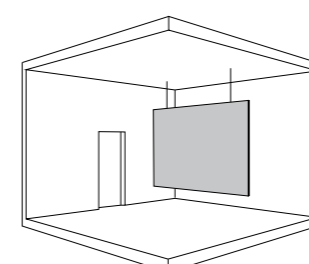
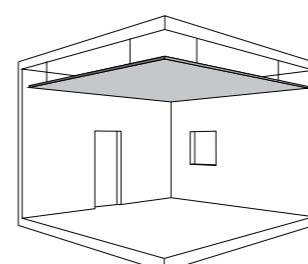
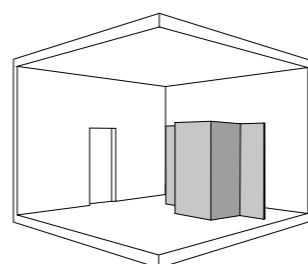

# ACOUSTIC PANEL



## FRAMFRAME silentis

decorative noise control

**IT |** una decorazione per interni con un nucleo intelligente: dietro il tessuto stampato in digitale troverete materiale isolante fonoassorbente. potrete usare i prodotti silentis come pareti divisorie flessibili, decorazioni di tendenza a parete o a sospensione. il banner in tessuto può essere cambiato facilmente in modo da rendere sempre attuale questo prodotto per l'insonorizzazione degli spazi. silentis: più benessere nel vostro ufficio.

**DE |** coole dekoration mit intelligentem kern: hinter dem bedruckten stoff steckt eine schall-absorbierende isolierung. sie können silentis produkte als flexible raumtrenner, dekorative wandgestaltung oder trendige deckenabhängung verwenden. der stoff lässt sich leicht austauschen, so bleibt dieser lärmschutz immer aktuell und wird nie langweilig. silentis: die intelligente lösung für mehr wohlbe finden im raum.

**EN |** a cool interior with an intelligent core: behind the digital printed textile there is noise absorbing isolating material. you can use the silentis products as flexible partition, decorative wall design or trendy ceiling suspension. the textile banner can be exchanged easily. this is a noise reducing product with an always up-to-date style. silentis: more wellness in your rooms.

FFS119001260	silentis 1900x1260mm, 1pc
FFS11900660	silentis 1900x660mm, 1pc
FFRB300100	framframe base, 2pcs



banner not included



banner not included



# PARTITION



## DIGIPRESSTO

freestanding for rigid panels

**IT |** pratico per costruire velocemente elementi divisori flessibili: scegliete come parete divisoria la base digipresso con un pannello in legno, vetro o forex. i profili in alluminio anodizzato color argento sostengono i vostri pannelli in sicurezza e per il montaggio non è necessario nessun tipo di attrezzo.

**DE |** praktisch für schnelle und flexible raumtrennung: setzen sie die digipresso standfüsse mit paneelen aus holz, glas, bedrucktem hartschaum oder verbundplatten ganz einfach als clevere raumteiler ein. die silber eloxierten aluminium - profile klemmen ihre paneele sicher ein und sind ohne werkzeug schnell auf- und abgebaut.

**EN |** convenient for quick and flexible partitions: use the digipresso base with panels made of wood, glass, printed rigid foam or composite panels as a trendy partition. the silver anodized aluminium profiles clamp your panels safely and are set up without any tools in no time at all.

PT300 digipresso silver 300mm, 1pc

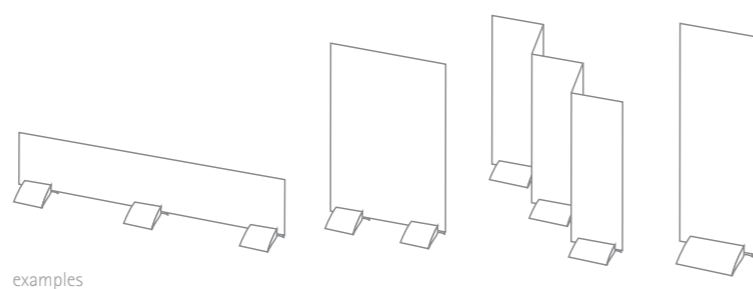

examples



panel not included

# MODULAR CUBES



## CONNECTOR

modular modern style

**IT |** con i connettori trasparenti potrete realizzare diverse strutture cubiche. il risultato migliore lo avrete utilizzando pannelli in acrilico. che sia un sistema per l'archiviazione dei vostri raccoglitori o una teca, con connector potrete dare forma alla vostra idea di stile.

**DE |** vielfältige würfelstrukturen lassen sich modular mit den transparenten connector verbinden bauen. am besten passen dazu transparente acrylglasplatten. ob als transparentes archiv für ihre ordner oder kleine ausstellungsvitrine, mit connector lässt sich kreativ einrichten.

**EN |** multiple cubic structures can be realized with the transparent connector. they match best with acrylic sheet panels. whether transparent archives for your folders or as a display cabinet, with connector you can design your own creative interior style.

4XFCONA+4XFCON330PL connector cube, 1pc

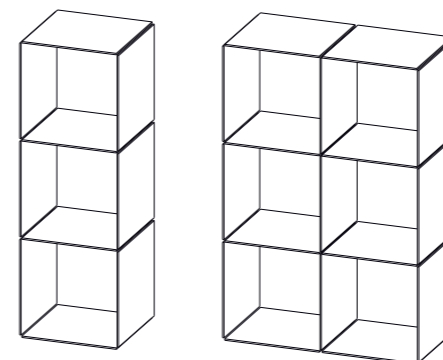

examples



folder not included



# PARTITION



## ixBOND

multi purpose connector

**IT |** date stile alle pareti divisorie con i nostri connettori ixbond, eleganti supporti in alluminio anodizzato a 4 diverse angolazioni. uniscono all'infinito i vostri pannelli stampati, che siano questi in legno o vetro. pareti divisorie, contenitori o colonne informative, ixbond per tutto questo ed altro.

**DE |** stilvolle trennwände ermöglichen unsere verbinder aus der ixbond serie. edel in matt-silber gibt es die ixbond für 4 verschiedene winkel. stufenlos verbinden sie ihre bedruckten verbundplatten, holz- oder glaspanelee zu cleveren elementen. ob raumtrenner, behälter oder infosäule, die ixbond verbinder machens möglich.

**EN |** stylish partitions become real with our ixbond connectors. elegant matt silver supports for 4 different angles. they connect your printed composite panels, wood or glass sheets to make an infinity of shapes. partitions, containers or information pillars, the ixbond connectors make it real.

IX2B60AR	ixbond connector 60°, 1pc
IX2B90AR	ixbond connector 90°, 1pc
IX2B120AR	ixbond connector 135°, 1pc
IX2B180AR	ixbond connector 180°, 1pc
IX2BSWAR	ixbond sandwich connector, 1pc



panel not included

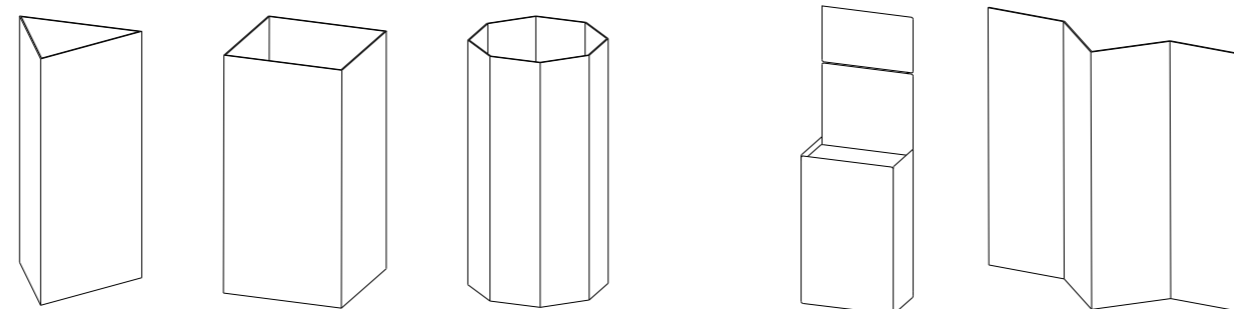

examples





patented

## SOISTES® POLE

stable, flexible elegant

**IT |** con il sistema di fissaggio pole della nostra linea soistes® le strutture sono fissate in sicurezza tra soffitto e pavimento senza fori nelle pareti. i ripiani in vetro temperato satinato sono liberamente combinabili e regolabili in altezza, utilizzati in combinazione con i profili in alluminio anodizzato rendono l'intero spazio elegante fin nei minimi dettagli.

**DE |** mit dem spannsystem pole aus der soistes® serie werden die strukturen sicher zwischen decke und boden verklemmt - ganz ohne bohrungen. frei kombinierbare und höhenverstellbare ablagen aus satiniertem sicherheitsglas sowie elegantes silbermattes aluminium machen die faszination dieses raumelements aus.

**EN |** with the clamp system pole from our soistes® series the structures are safely clamped between ceiling and floor without drilling any holes. freely combinable and regulable in height are the shelves made of satinized tempered glass. together with the silver anodized aluminium profiles those make this interior detail a very special and elegant one.

OUR EXAMPLE



banner not included



patented

## SOISTES® STORE

convenient and handy

**IT |** questo sistema della famiglia soistes® è pratico e flessibile. i ripiani in vetro temperato sono regolabili in altezza. la struttura in alluminio anodizzato color argento sostenuto da basi stabili in metallo argentato pressofuso.

**DE |** praktisch und flexibel ist dieses regalsystem aus der soistes® familie. die fachböden aus temperiertem sicherheitsglas sind höhenverstellbar. die struktur aus silber eloxiertem aluminium steht sicher auf zwei stabilen füssen aus silbermatt beschichtetem metall-druckguss.

**EN |** convenient and handy is this rack from our soistes® programme. the shelves made of tempered glass are adjustable in height. the structure made of silver anodized aluminium stands safely on two strong feet made of matt silver coated metal die-cast.

SOST650VE

store soistes, 1pc

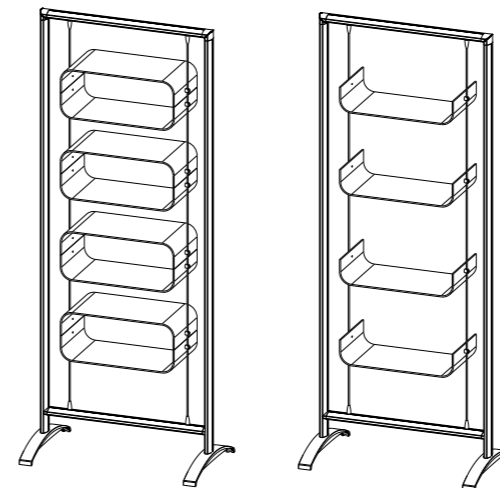

examples



folder not included



patented

## SOISTES® FLY CART

suspended rack system

**IT |** un elegante sistema a sospensione combinato con una struttura autoportante e ripiani in acrilico satinato: questo è soistes® fly. leggero e trasparente è perfetto per le vostre presentazioni di oggetti non troppo pesanti.

**DE |** ein elegantes seilspannsystem in kombination mit einer freistehenden struktur und satinierten acrylglas ablagen: das ist soistes® fly. das leicht und transparent wirkende element eignet sich perfekt für ihre präsentation von objekten mit geringem gewicht.

**EN |** an elegant suspension system in combination with a freestanding structure and satined acrylic: this is soistes® fly. it looks airy yet transparent and is perfect for your presentation of light weight objects.

SOYCART900 soistes fly cart, 1pc

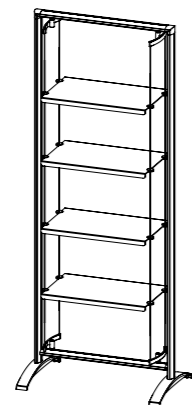

shoes not included



## SNAPIN

trendy frame

**IT |** snapin, la combinazione ideale tra alluminio color argento opaco e acrilico trasparente. immagini o informazioni possono essere cambiate facilmente. potete utilizzare la cornice snapin orizzontalmente, verticalmente o inclinandola.

**DE |** eine gelungene kombination aus silbermatt aluminium und transparentem acryl ist der snapin rahmen. bilder aber auch informationen können jederzeit ganz einfach ausgetauscht werden. die snapin rahmen lassen sich horizontal, vertikal aber auch liegend verwenden.

**EN |** a successful combination of silver matt aluminium and transparent acrylic is the snapin frame. pictures or information can be easily exchanged anytime. you can use the snapin frames vertically, horizontally and reclined.

SNIA5 snapin A5, 1pc

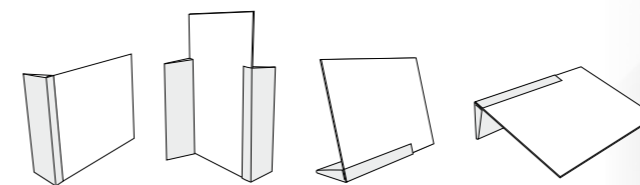

examples



print not included



## DACAPO

easily attached

**IT |** un binario da fissare a parete con doppia funzione: è possibile inserire nella parte inferiore disegni, piantine e immagini o, nel binario stesso, tasche trasparenti portacataloghi o documenti; e tutto questo resta fissato a parete grazie all'innovativo design! le tasche sono senza fori, potrete così utilizzarle anche come vasi per le vostre piante da interno creando in ufficio il vostro giardino verticale!

**DE |** eine schiene mit doppelfunktion: zeichnungen, pläne oder bilder von unten einfach einschieben, sie halten dank des cleveren designs. für kataloge und andere unterlagen einfach die transparenten container einhängen. die container sind übrigens geschlossen und können bepflanzt werden. eine tolle idee für jedes büro!

**EN |** a wall rail with a double function: simply insert drawings, maps or images from below. they stay on the wall thanks to its clever design. for brochures and documents simply attach the transparent containers. by the way: the containers come without holes so you can use them for your indoor plants and create a vertical garden in your office!

DCR1000	da capo rail 1m, 1pc
DCTA6	da capo tray A6, 1pc
DCTA5	da capo tray A5, 1pc
DCTA4	da capo tray A4, 1pc

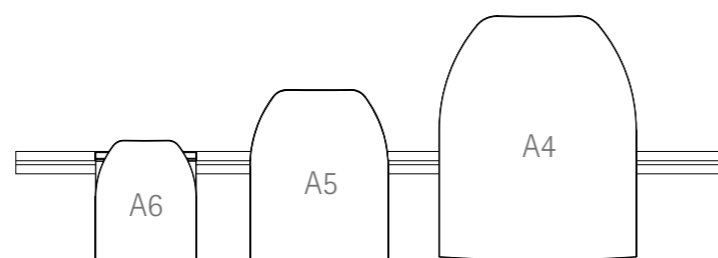

## DACAPO IPOINT

freestanding and flexible

**IT |** design semplice e moderno da ora anche flessibile: è sufficiente agganciare le tasche trasparenti al display bifacciale nero opaco con cornice argentata e il gioco è fatto. sono disponibili tasche in diversi formati: A4, A5 e A6.

**DE |** schlankes, modernes design und äusserst flexibel: in das doppelseitige schwarzmatte display mit den silbermatten seiten werden die transparenten container einfach ein-, aus- und umgehängt. container für format A4, A5 und A6 stehen für sie zur auswahl bereit.

**EN |** lean and modern design yet very flexible: simply insert into the double side black matt display with silver matt frame the transparent containers. we have containers in A4, A5 and A6 sizes for you to choose from.

DCI1730250SZ dacapo ipoint black, 1pc



## REAL ZIP

foldable, transportable, flexible

**IT |** tempo di montaggio? un lampo: questo conveniente portadepliant con 4 tasche portacataloghi in formato A4 si monta con un solo movimento, reggendosi stabilmente sulla sua base argentata; sul pannello frontale è possibile applicare una stampa per personalizzare il vostro real zip a seconda dell'occasione; per fiere eventi o altre presentazioni con real zip sarete perfettamente attrezzati.

**DE |** im nu aufgestellt ist dieser praktische prospektständer: die 4 prospektfächer für A4 falten sich mit einem handgriff auf und stehen sicher. das frontpaneel lässt sich einfach mit einem ausdrück passend zum event personalisieren. ob messe, event oder präsentation mit dem real zip machen sie immer gute figur!

**EN |** set up in no time at all: this convenient brochure holder folds up it's 4 brochure pockets for format A4 just in one movement. it stands stable on its silver matt base. inside the front panel you can put a print and easily customize your real zip according to the occasion. at exhibitions, for events or other presentations: with the real zip you will be perfectly equipped.

RZ4AA realzip 4 pockets A4, silver base, 1pc



panel not included



## LUMO

slim look, modern style

**IT |** elegante e sottile, ecco come si presenta il pannello retroilluminato della linea lumo. cambio rapido delle informazioni o immagini grazie al foglio protettivo flessibile dotato di strisce magnetiche. l'illuminazione a led a lunga durata garantisce una illuminazione uniforme dagli angoli fino al centro, mettendo in risalto le vostre immagini.

**DE |** ganz schlank und edel präsentiert sich der leuchtrahmen lumo. schnell lässt sich ihr bild oder die info auswechseln, dank der flexiblen coverfolie mit magnetstreifen. die ausleuchtung ist perfekt bis ins zentrum und die langlebigen led schaffen mit ihren bildern eine ganz besondere atmosphäre.

**EN |** very slim and elegant is the light panel from the lumo series. quick exchange of the information or decorative image thanks to the flexible transparent cover foil held by magnetic strips. the illumination is perfectly uniform from edge to center and the long life led makes your images a very special eye catcher.

LUMOA3 lumo A3, 1pc



banner not included



glass not included

## FISSO FOUR

wall spacer with style

**IT |** i distanziali per segnaletica della linea fisso daranno alle vostre targhe un tocco veramente speciale: gioielli quadrati con finitura di alta qualità. lo speciale design rende il montaggio veloce e facile e, allo stesso tempo, a prova di manomissione.

**DE |** abstandhalter für beschilderung der serie fisso mit ganz besonderem stil: viereckige schmuckstücke aus metalldruckguss mit hochwertiger oberflächenveredelung. das spezielle design erlaubt nicht nur die schnelle und unkomplizierte montage, sondern schützt ihre schilder auch vor manipulationen durch dritte.

**EN |** spacers for signage from the fisso range with a very special touch: square gems with a high quality surface finish. the special design makes the mounting quick and easy, while your sign is tamperproof.

FFT1621IX fisso four steel look, 4ps



# TECHNICAL DETAILS

**IT** | nelle pagine seguenti troverete tutte le informazioni nel dettaglio per i vostri ordini: i codici degli articoli, versioni e misure disponibili, disegni tecnici, materiale compreso nella confezione e molto altro ancora. avete bisogno di ulteriori informazioni? non esitate a chiedere, saremo lieti di potervi aiutare!

**DE** | auf den folgenden seiten finden sie alle nötigen detailinformationen für ihre bestellung: artikelcode, verfügbare grössen und varianten, materialien, technische zeichnungen, lieferumfang und vieles mehr. sollte das gesuchte nicht dabei sein, fragen sie uns, wir beraten sie gerne persönlich!

**EN** | on the following pages you will find all the required information in detail for your orders: item codes, available sizes and versions, materials, technical drawings, material included in delivery and much more. if you cannot find here what you are looking for, ask us, we are happy to assist you.

## SIGNCODE®

inserire nella cornice il pannello in alluminio o in PS trasparente e chiudere il sistema lateralmente. per aprire la cornice basta premere sul gancio di sicurezza con una tessera plastificata tipo carta di credito.  
**paneel aus alu oder transparentem PS einschieben und seitlichen verschluss einklicken. zum öffnen einfach die sicherung mit einer scheckkarte lösen.**  
 insert panel made of aluminium or transparent PS and click in the lateral side part for opening simply loosen the latch with a slim card.

ordinare extra per flag e ceiling  
**inbus-schlüssel für flag und ceiling extra bestellen**  
 order key for flag and ceiling separately

33 ACHI20 allen key, 1pc



**aluminium panel**  
 pannello in alluminio, spessore 1,2 mm, di colore bianco RAL9016, per decorazione con pellicole adesive o per stampa diretta  
**aluminium panel 1,2mm beschichtet in RAL9016 weiss, für aufkaschieren oder direktdruck**  
 aluminium panel 1,2mm coated in RAL9016 white, for laminating or direct printing



**non reflective PS**  
 protettivo trasparente in PS antiriflesso, spessore 1,2 mm, per stampa su carta o stampato direttamente  
**abdeckung aus 1,2mm starkem nicht reflektierendem PS, für papierdruck, kann direkt bedruckt werden.**  
 cover made of 1,2mm thick non reflective PS, for paper prints, it can also be laminated or printed on the rear side.

### signcode wall



targa a parete monofacciale  
**einseitiges wandschild**  
 single side wall sign

altezza x larghezza | höhe x breite | height x width

1	FSOW148148AL	148x148mm
2	FSOW297297AL	297x297mm
3	FSOW148600AL	148x600mm
4	FSOW2101200AL	210x1200mm

5	FSOW148148PS	148x148mm
6	FSOW297297PS	297x297mm
7	FSOW148600PS	148x600mm
8	FSOW2101200PS	210x1200mm

### signcode flag

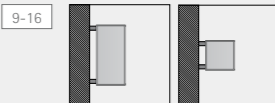

targa a bandiera bifacciale  
**doppelseitiges fahnen- bzw. auslegerschild**  
 double sided flag sign

altezza x larghezza | höhe x breite | height x width

9	FSOF148148AL	148x148mm
10	FSOF297297AL	297x297mm
11	FSOF148210AL	148x210mm
12	FSOF297210AL	297x210mm

13	FSOF148148PS	148x148mm
14	FSOF297297PS	297x297mm
15	FSOF148210PS	148x210mm
16	FSOF297210PS	297x210mm

### signcode ceiling



targa a soffitto bifacciale  
**doppelseitiges deckenschild**  
 double sided ceiling sign

applicazione su richiesta  
**anwendungsvariante auf anfrage**  
 application on demand

altezza x larghezza | höhe x breite | height x width

17	FSOC105297AL	105x297mm
18	FSOC105800AL	105x800mm
19	FSOC2101000AL	210x1000mm
20	FSOC297600AL	297x600mm

21	FSOC105297PS	105x297mm
22	FSOC105800PS	105x800mm
23	FSOC2101000PS	210x1000mm
24	FSOC297600PS	297x600mm

### signcode suspension

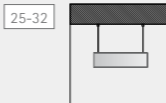

sistema bifacciale sospeso su cavi di acciaio, variabile fino ad un mass. di 1m  
**doppelseitig für abhängung am seil, stufenlos verstellbar bis max. 1m**  
 double-side sign for ceiling suspension, steplessly adjustable up to max. 1m

applicazione su richiesta  
**anwendungsvariante auf anfrage**  
 application on demand

altezza x larghezza | höhe x breite | height x width

25	FSOS105210AL	105x210mm
26	FSOS105800AL	105x800mm
27	FSOS210800AL	210x800mm
28	FSOS2971000AL	297x1000mm

29	FSOS105210PS	105x210mm
30	FSOS105800PS	105x800mm
31	FSOS210800PS	210x800mm
32	FSOS297600PS	297x600mm

altre misure su richiesta, materiale per il montaggio incluso | andere größen auf anfrage, montage-material inkl. | other sizes upon request, mounting material incl.

## PIXQUICK®

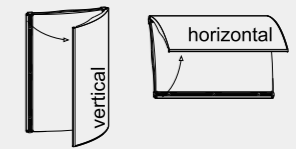
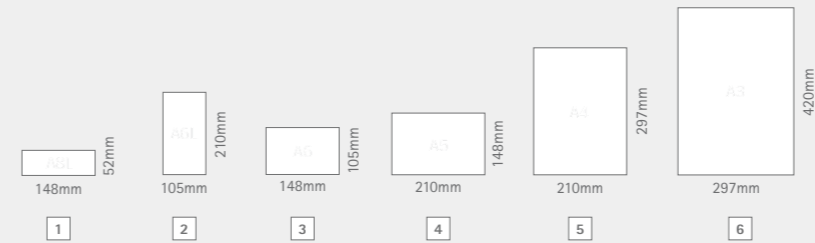

girare pixquick® per cambiare facilmente formato da orizzontale a verticale e viceversa  
**im handumdrehen von vertikal auf horizontal umstellen**  
 just rotate for vertical or horizontal position



1	PQA8L	pixquick A8L, 1pc
2	PQA6L	pixquick A6L, 1pc
3	PQA6	pixquick A6, 1pc
4	PQA5	pixquick A5, 1pc
5	PQA4	pixquick A4, 1pc
6	PQA3	pixquick A3, 1pc

## MAGINFO SLIM

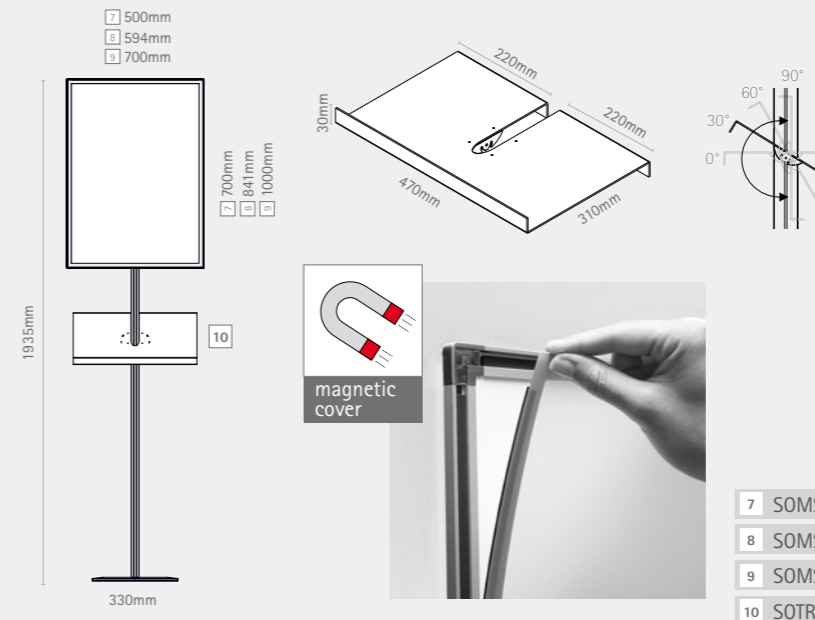

ripiano per 2 depliant in A4 verticale, acrilico satinato, inclinabile orizzontalmente e posizionabile liberamente su tutta la lunghezza del profilo.  
**ablage für 2 A4 aus satiniertem acrylglas, horiz. neigbar und stufenlos höhenverstellbar**  
 satin acrylic tray for 2 A4 sized literature, these trays are adjustable horizontally and in height.

7	SOMS700500	maginfo slim 700x500mm, 1pc
8	SOMSA1	maginfo slim A1, 1pc
9	SOMS1000700	maginfo slim 1000x700mm, 1pc
10	SOTR2A4TR	tray 2 A4 V, 1pc

altre misure su richiesta | andere maße auf anfrage | other measure upon request

## IPOINT MEDIA

## IPOINT

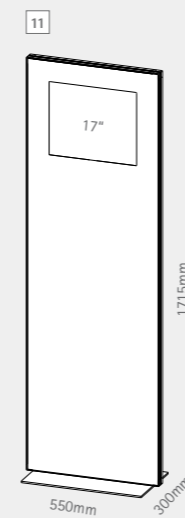

base in metallo verniciato a polvere di color nero, estrusioni in alluminio anodizzato color argento, pannelli alu-bond color nero con schermo lcd 17"  
**basis metall schwarz pulver beschichtet, rahmen silber eloxiertes aluminium, schwarzes aluminium verbundpaneel mit lcd bildschirm 17"**  
 black powder coated metal base, frame silver anodized aluminium, black aluminium composite panel with lcd screen 17"



memory card not included



sul retro si trova l'interfaccia per la memory card o usb e l'uscita per il cavo  
**auf der rückseite befindet sich die schnittstelle für memory card oder usb sowie der kabelausgang**  
 on the rear side you find the interfaces for memory card or usb and the exit of the cable.

11 IPM17 ipoint media 17" black, 1pc

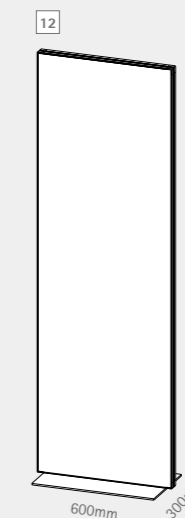

profili in alluminio anodizzato, angoli in zamac e base metallica verniciata a polvere color argento, pannelli di alluminio composito color bianco opaco e argento. dopo la personalizzazione i pannelli devono essere incollati sulla struttura.  
**silber elox-aluminium profil, basis metall silber pulverbeschichtet, alu-verbundpaneel mattweiss/silber, eckverbinder versilberter metall-druckguss. nach personalisierung muss das verbundpaneel direkt mit profilrahmen verklebt werden.**  
 silver anodized aluminium extrusion, base silver coated metal, aluminium composite panel matt white/silver, edge connectors silver-plated die-cast metal. after customization the composite panel must be glued to the frame.

12 IP1900600ARW ipoint 1900x600 silver/white, 1pc

altre misure su richiesta | andere maße auf anfrage | other measure upon request



stopper point alu | black



- 1 SCPALARGSW stopper point alu with black ribbon, 1pc
- 2 SCPSSWSSW stopper point black with black ribbon, 1pc

tex alu | tex alu mini

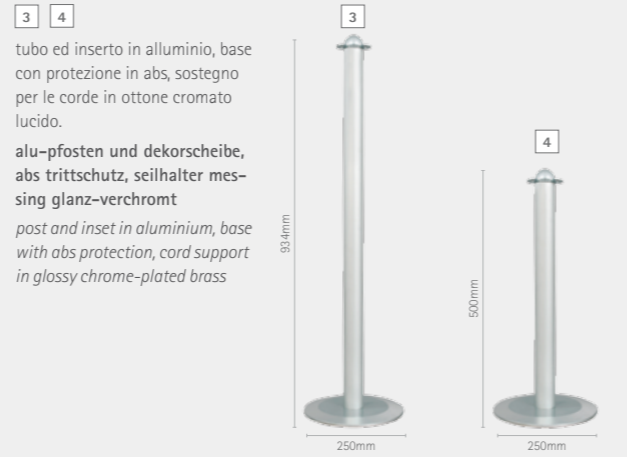

- 3 TXAL set stopper tex alu, 1pc
- 4 TXALMI set stopper tex alu mini, 1pc



resistente alle grinzanti-knitter gurt anti-crease webbing

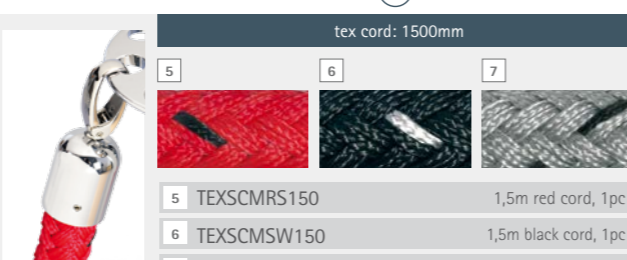

tex cord: 1500mm

- 5 TEXSCMRS150 1,5m red cord, 1pc
- 6 TEXSCMSW150 1,5m black cord, 1pc
- 7 TEXSCMGR150 1,5m grey cord, 1pc

altre misure e composizioni su richiesta | andere maße und ausföhrungen auf anfrage | other measure and models available upon request

framframe



- 8 FFR1500500 1500x500mm, 1pc
- 9 FFR2000800 2000x800mm, 1pc
- 10 FFR20001000 2000x1000mm, 1pc
- 11 FFR19001260 1900x1260mm, 1pc
- 12 FFR25001500 2500x1500mm, 1pc
- 13 FFR25002500 2500x2500mm, 1pc

framframe silentis

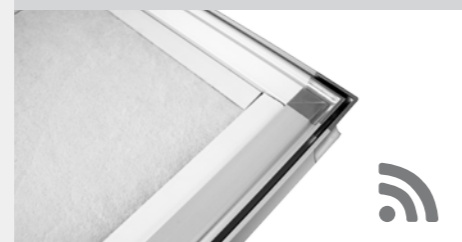

- 14 FFSI660660 silentis 660x660mm, 1pc
- 15 FFSI1260660 silentis 1260x660mm, 1pc
- 16 FFSI12601260 silentis 1260x1260mm, 1pc
- 17 FFSI1900660 silentis 1900x660mm, 1pc
- 18 FFSI19001260 silentis 1900x1260mm, 1pc



inserire il banner di tessuto con le strisce di silicone partendo dagli angoli  
stoffbanner mit silikonlippe von den ecken ausgehend frontal einsetzen  
textile banners are mounted easily with silicone seam starting from the edges

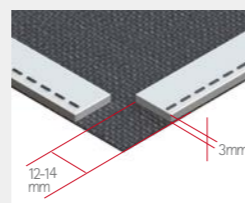

accessories

framframe wall support



fissaggio murale per framframe in metallo verniciato color argento  
wandhalter für framframe, metall silberlackbeschichtet  
wall support for framframe made of silver varnished metal

- 19 FFRWS framframe wall support, 2pcs

framframe & silentis free standing



base di appoggio in metallo verniciato color argento  
bodenplatte aus silberlackiertem metall  
floor plate made of silver varnished metal

- 20 FFRB300100 framframe & silentis base, 2pcs

altre misure e composizioni su richiesta | andere maße und ausföhrungen auf anfrage | other measure and models available upon request

anodized aluminium profile



profilo in alluminio anodizzato con protezione anti-scivolo, vite a testa zigrinata  
klemmprofil aus eloxiertem aluminium, mit anti-rutschschutz und rändelschraube

clamping profile made of anodized aluminium with anti-slip protection and knurled head screw

- 1 PT235 digipresto silver 235mm, 1pc
- 2 PT300 digipresto silver 300mm, 1pc
- 3 PT400 digipresto silver 400mm, 1pc
- 4 PT500 digipresto silver 500mm, 1pc

lateral cover caps



tappi laterali abs nero, set con 4 pz  
seitenabdeckkappen abs schwarz, set mit 4 stück

lateral cover caps abs black, set with 4 pcs

- 5 PTAKSZ cover caps black, 4pcs

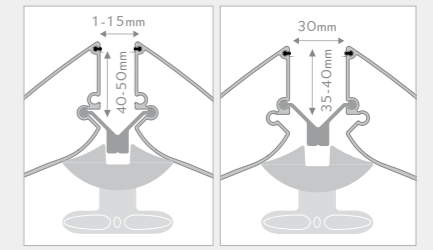

per pannelli con spessore da 1mm a 15mm e 30mm. l'altezza massima del pannello varia a seconda del materiale utilizzato e del suo spessore. ogni applicazione deve essere verificata prima della installazione.

für platten von 1-15mm und 30mm geeignet. maximale paneel-höhe und -breite sind vom verwendeten plattenmaterial abhängig. jede anwendung ist daher individuell auf eignung zu prüfen.

for panels with thicknesses from 1-15mm and 30mm. maximum panel height and width depend on the used material. every application has to be approved individually if appropriate.

panel connector: glassgreen polycarbonat for modular cube systems

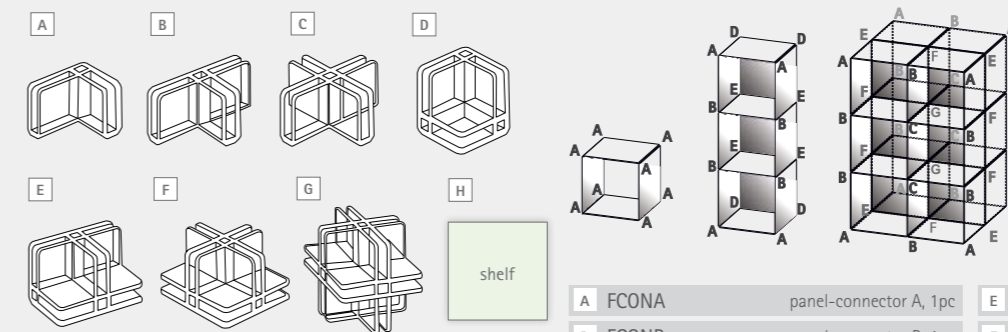

connettori antiurto in policarbonato stampati ad iniezione per pannelli da 5mm  
schlagfeste polycarbonat verbindler für paneele mit 5mm  
shock-resistant connectors made of polycarbonate die-cast for panels with 5mm

- A FCONA panel-connector A, 1pc
- B FCONB panel-connector B, 1pc
- C FCONC panel-connector C, 1pc
- D FCOND panel-connector D, 1pc
- E FCONE panel-connector E, 1pc
- F FCONF panel-connector F, 1pc
- G FCONG panel-connector G, 1pc
- H FCON330PL shelf 330x330x5mm, 1pc

panel connector: silver plated die-cast metal, stainless steel screw

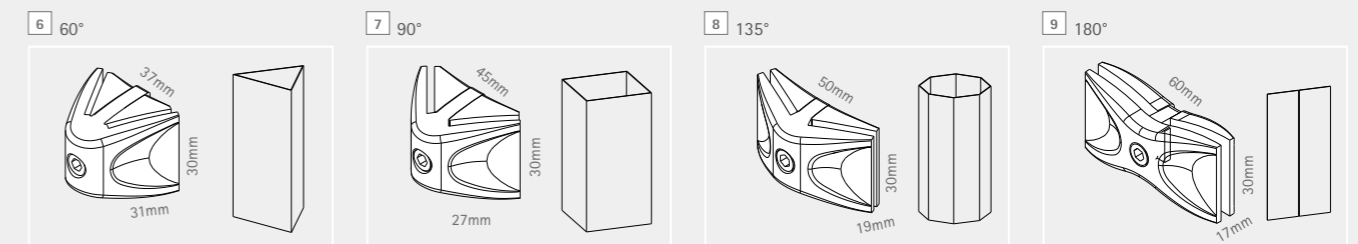

sandwich system

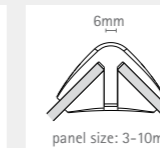
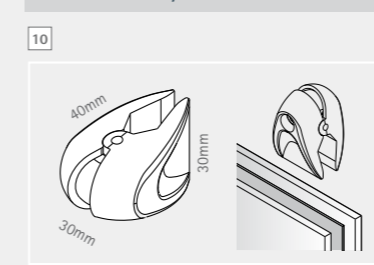

connettori pannelli di zamac color argento satinato  
paneelverbinder aus silberbeschichtetem metall-druckguss  
panel connector made of silver coated die-cast metal

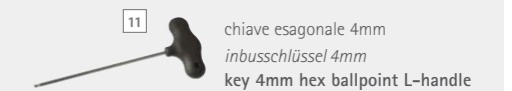

- 6 IX2B60AR 60° connector, 1pc
- 7 IX2B90AR 90° connector, 1pc
- 8 IX2B120AR 135° connector, 1pc
- 9 IX2B180AR 180° connector, 1pc
- 10 IX2BSWAR ixbond sandwich connector, 1pc
- 11 SOKEY4 t-handle hex key, 1pc

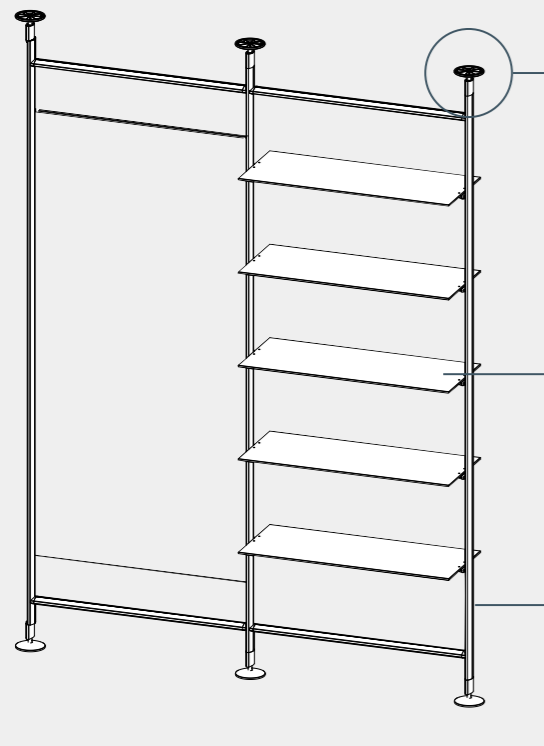

metallo pressofuso color argento opaco, profilo di aggancio in alluminio anodizzato  
*silber matt verchromter metall-druckguss, silber eloxierte alu-miniumprofile*  
 silver matt plated die cast metal, silver anodized aluminium profiles

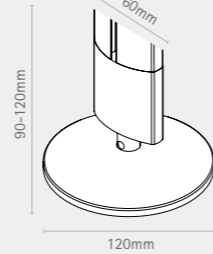

ripiano in vetro temperato, spessore 8mm. fondo satinato e con il marchio  
*fachboden aus temperiertem 8mm starkem glas. unterseite satiniert mit markenzeichen*  
 shelf made of tempered 8mm thick glass. rear side satined and brand marked

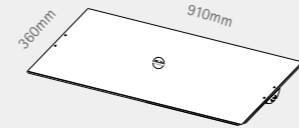

profili in alluminio anodizzato, connettori di metallo in pressofusione  
*silber eloxiertes alu-profil, versilberter metalldruckguss*  
 silver anodized aluminium profile, silver-plated metal die-cast connectors

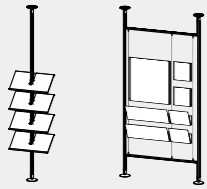
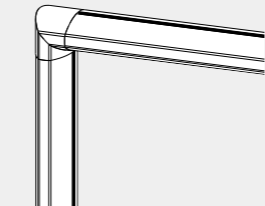

PROFILE YOURSELF!®

non esitate a contattarci per realizzare il vostro sistema di arredo personalizzato con soistes®, saremo felici di potervi aiutare.  
*für ihre individuelle einrichtung mit soistes® fragen sie uns, wir beraten sie gerne persönlich.*  
 for your individual interior with soistes® please contact us. we are happy to assist you.

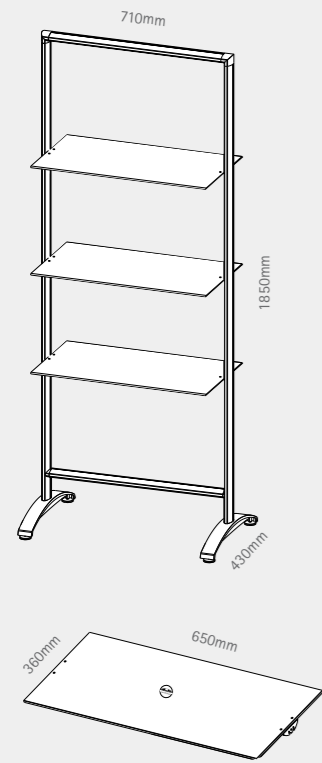

struttura in alluminio anodizzato color argento con connettori e piedini in metallo a pressofusione color argento, 3 ripiani in vetro temperato, spessore 8mm. fondo satinato e con il marchio.  
*struktur aus silbereloxiertem aluminiumprofilen, verbinder und füsse aus versilbertermetalldruckguss, 3 fachböden aus 8mm starkem temperiertem glas. unterseite satiniert mit logoeindruck.*  
 structure made of silver anodized aluminium profiles, connectors and feet made of silver plated die-cast metal. 3 shelves made of tempered 8mm thick glass. rear side satin and brand marked.

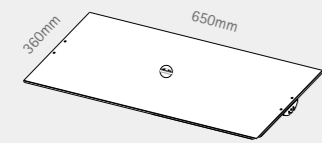

1 SOST650VE store soistes, 1pc

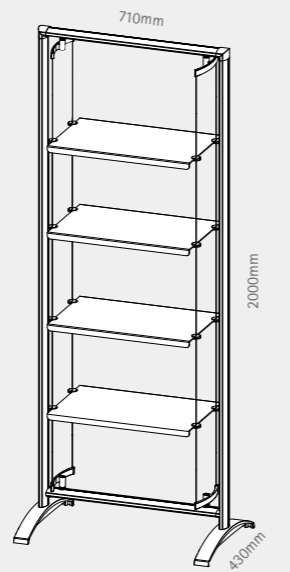

struttura in alluminio anodizzato color argento con connettori e piedini in metallo a pressofusione color argento, 4 ripiani in acrilico satinato su cavi d'acciaio.  
*struktur aus silbereloxiertem aluminiumprofilen, verbinder und füsse aus versilbertermetalldruckguss, 4 fachböden aus satiniertem acrylglas, spannsystem.*  
 structure made of silver anodized aluminium profiles, connectors and feet made of silver plated die-cast metal. 4 shelves made of satin acrylic, cable suspension system.

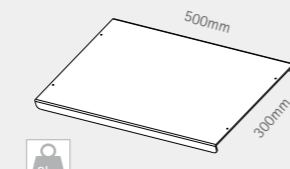

2 SOYCART900 soistes fly cart, 1pc

base: aluminium extrusion

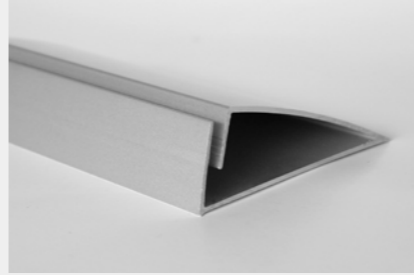

1	SNIA7	snapin 74mm, 1pc
2	SNIA6	snapin 105mm, 1pc
3	SNIA5	snapin 148mm, 1pc
4	SNIA4	snapin 210mm, 1pc
5	SNIA3	snapin 297mm, 1pc
6	SNI500	snapin 500mm, 1pc

poster pocket: transparent acrylic



7	SNRTA7	poster pocket A7, 1pc
8	SNRTA6	poster pocket A6, 1pc
9	SNRTA5	poster pocket A5, 1pc
10	SNRTA4	poster pocket A4, 1pc
11	SNRTA3	poster pocket A3, 1pc

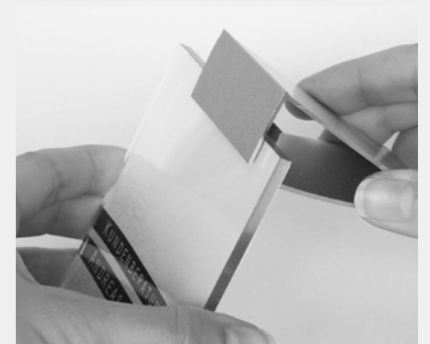
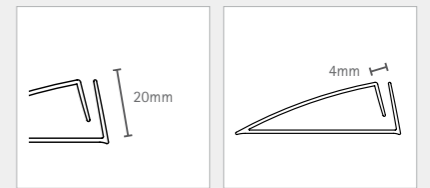

altre misure e composizioni su richiesta | andere maße und ausführungen auf anfrage | other measure and models available upon request

aluminium rail

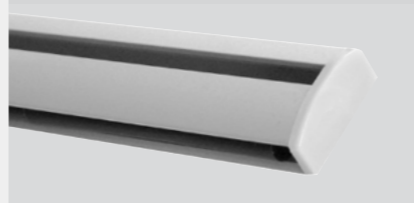

profilo in alluminio anodizzato, materiale per il montaggio incluso  
 eloxiertes aluminiumprofil, komplett mit montageset  
 anodized aluminium rail, including mounting kit

12	DCR500	dacapo rail 500mm, 1pc
13	DCR1000	dacapo rail 1000mm, 1pc
14	DCR1500	dacapo rail 1500mm, 1pc
15	DCR2000	dacapo rail 2000mm, 1pc

attachable container



contenitore da appendere in formato DIN A4, DIN A5 o DIN A6, in polistirolo  
 box zum einhängen für DIN A4, DIN A5 oder DIN A6 format, aus polystyrol  
 container attachable for DIN A4, DIN A5 or DIN A6 format, made of polystyrene

16	DCTA6	container A6, 1pc
17	DCTA5	container A5, 1pc
18	DCTA4	container A4, 1pc

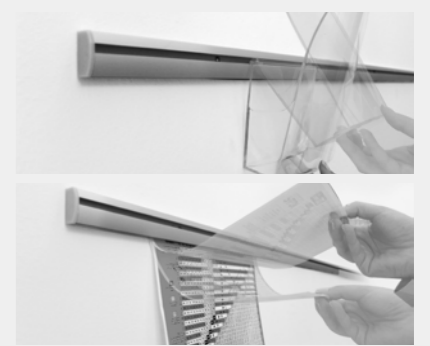
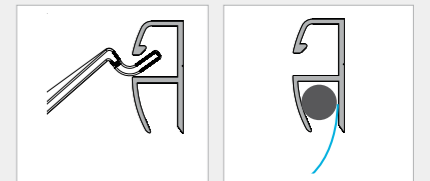

altre misure del profilo su richiesta | andere maße der schiene auf anfrage | other rail measure upon request

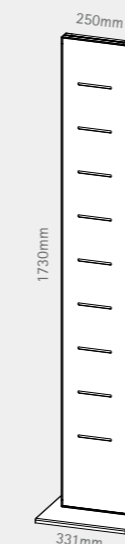

19 DCI1730250SZ dacapo ipoint black, 1pc

display da terra bifacciale autoportante. cornice in alluminio anodizzato color argento, pannello in alu bond color nero, base color nero opaco  
 doppelseitiges freistehendes bodendisplay: silbereloxierter alu-rahmen, schwarzes alu-verbundpaneel, schwarz-matte basis  
 double-side freestanding floordisplay: silver anodized aluminium frame, black aluminium composite panel, black matt base.

attachable container



contenitore da appendere in formato DIN A4, DIN A5 o DIN A6, in polistirolo  
 box zum einhängen für DIN A4, DIN A5 oder DIN A6 format, aus ps-polystyrol  
 container attachable for DIN A4, DIN A5 or DIN A6 format, made of polystyrene

20	DCTA6	container A6, 1pc
21	DCTA5	container A5, 1pc
22	DCTA4	container A4, 1pc



\* in vendita da aprile 2013 | auslieferung ab april 2013 | on sale from april 2013

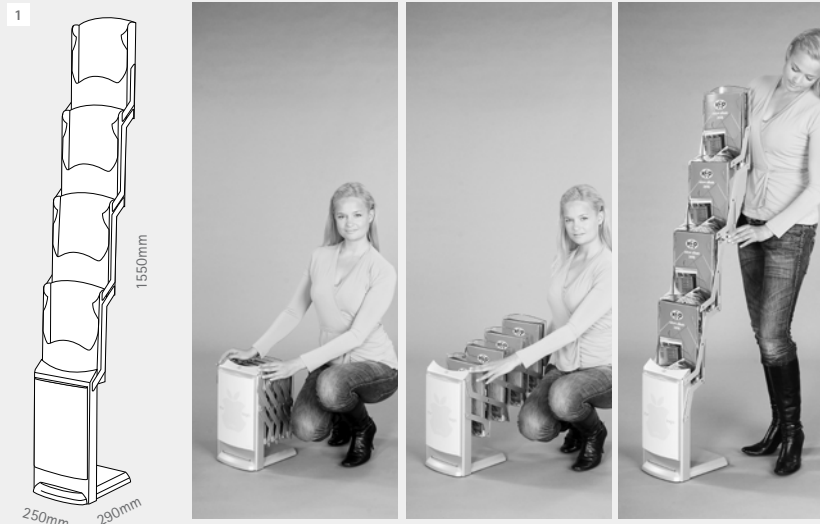

espositore portacataloghi pieghevole con 4 tasche stampate ad iniezione in policarbonato robusto e di lunga durata. personalizzazione semplice e veloce, basta stampare la grafica desiderata, inserirla nel pixquick e il gioco è fatto!

mobiles, faltbares prospektdisplay mit 4 prospektschalen aus robustem, langlebigem polycarbonat. frontpaneel schnell und einfach personalisiert: grafik ausdrucken, einlegen, fertig!

mobile, foldable brochure display with 4 trays made of long life die-cast polycarbonate. quick and easy customizing: print your graphics, insert into the pixquick, ready!

1 RZ4AA real zip 4 pockets, silver base, 1pc

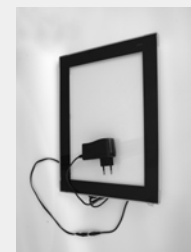
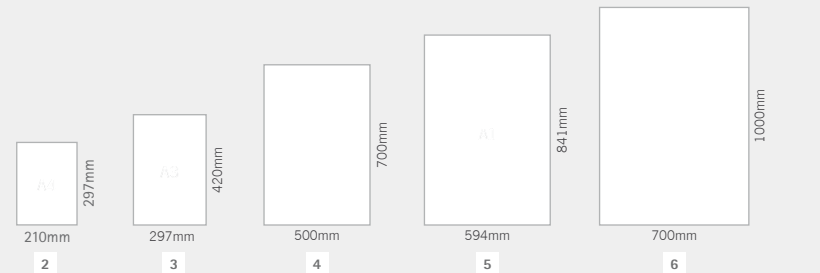

acrilico inciso per un'illuminazione uniforme, led a lunga durata, profilo in alluminio anodizzato color argento, connettori in zamac, passe-partout con strisce magnetiche.

graviertes acryl mit gleichmässiger ausleuchtung, langlebige LED, silber eloxiertes aluminium, eckverbinder aus metalledruckguss, passe-partout mit magnetbefestigung

engraved acrylic with uniform illumination, long-lasting LED, silver anodised aluminium profile, connectors made of zamac, passe-partout with magnets



led-lights

2	LUMO A4	lumoa4, 1pc
3	LUMO A3	lumoa3, 1pc
4	LUMO 700x500	lumoa700500, 1pc
5	LUMO A1	lumoa1, 1pc
6	LUMO 1000x700	lumoa1000700, 1pc

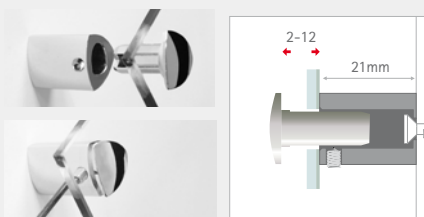

chromo   chrom   chrome	oro   gold   gold	steel look   steel look   steel look
A 7 FFT1621CM-SET 4pcs	A 13 FFT1621GD-SET 4pcs	A 19 FFT1621IX-SET 4pcs
B 8 FFF1621CM-SET 4pcs	B 14 FFF1621GD-SET 4pcs	B 20 FFF1621IX-SET 4pcs
C 9 FFS1621CM-SET 4pcs	C 15 FFS1621GD-SET 4pcs	C 21 FFS1621IX-SET 4pcs
argento   silber   silver	rame satinato   kupfer matt   matt copper	bronzo veneziano   bronze veneziano   venetian brass
A 10 FFT1621AR-SET 4pcs	A 16 FFT1621MCO-SET 4pcs	A 22 FFT1621VB-SET 4pcs
B 11 FFF1621AR-SET 4pcs	B 17 FFF1621MCO-SET 4pcs	B 23 FFF1621VB-SET 4pcs
C 12 FFS1621AR-SET 4pcs	C 18 FFS1621MCO-SET 4pcs	C 24 FFS1621VB-SET 4pcs

zip  
presentazione Et portadepliant  
präsentation Et prospektständer  
presentation Et brochure holders



digi  
sistemi espositivi  
displays Et werbeträger  
digital print displays



fly  
presentazione su cavi e astine  
stab- und seilspannsysteme  
suspension systems



fisso  
targhe Et fissaggi  
befestigungen Et schilder  
signs Et fixings



shop  
allestimento Et arredamento  
ladenbau Et einrichtung  
shop fitting Et interiors



tutto e ancor di più per l' allestimento di negozi e per eventi: mobili completi, accessori e complementi modulari per l'arredo e l'allestimento creativo.

alles für die komplettausstattung von shops wie events: fertiges mobiliar, zubehör und modulare komponenten für die ganz individuelle einrichtung und den kreativen ladenbau.

all for the complete fitting of shops and events: ready to use furniture, accessories and modular components for very individual interiors and the creative shop fitters.



chi siamo

IT | K-D è fabbrica di design, atelier di idee e luogo di mercato situata sulle alpi meridionali. luogo ideale per designer e artisti, vi si incontrano anche commerciali ed esperti di mercato. le prime strabilianti idee si sono convertite oggi in una vasta e completa gamma di soluzioni standard per il punto vendita, lo showroom, l'ufficio e la casa. il nostro fiuto per i trend ci spinge verso il domani: soluzioni e prodotti artistici (kunst) - che siano fertilizzante (dünger) per i nostri clienti. abbiamo tante altre idee: contattateci e saremo lieti di consigliarvi sempre al meglio!

über uns

DE | K-D ist designfabrik, ideenatelier und marktplatz auf der alpensüdseite. ein ort für designer, künstler und vermarkter. clevere produktideen haben sich zu einer breiten palette an bewährten standardlösungen für point of sale, showroom, office und homebereich entwickelt. mit gespür für trends sorgen wir so für morgen: produktlösungen mit „kunst“ - „dünger“ für unsere kunden. fragen sie uns wir haben viele ideen und beraten sie gerne!

about us

EN | K-D today is a design factory, idea studio and market place in northern italy. a place for designers, artists and marketing. clever product ideas have grown into a large range of proven and tested standard solutions for point of sale, showroom and office. with a sense for trends we provide for the future product solutions with "art" (=kunst) bringing "fertiliser" (=dünger) to the business of our customers. we have many ideas for you. contact us and we will be happy to assist you!

salvo errori ed omissioni. ci riserviamo di apportare modifiche tecniche ai prodotti, senza preavviso.

fehler, - und technische änderungen vorbehalten.

errors and omissions excepted. we reserve the right to effect product technical modifications without prior notice.



comunicazione visiva  
visuelle kommunikation  
visual communication



espositori Et displays  
digitaldruck- und prospektdisplays  
digital printing Et brochure displays



sistemi guidalinee  
personenleitsysteme  
crowd control

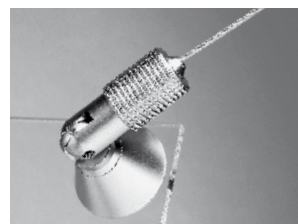

sistemi espositivi su cavi  
präsentationssysteme für spannsel  
suspension information systems



**KUNSTDÜNGER** srl

zona produttiva vezzano 7 | 39028 silandro (bz) ITALY  
tel. +390473 741500 | fax +390473 741600 | info@kdmarket.it  
[www.kdmarket.it](http://www.kdmarket.it)